

C SERIES

Surface Mount
Loudspeaker

Installation and
Operation Manual



MODELS

CS6 6.5" Full-Range





Important Safety Instructions

Always follow these basic safety precautions when using or installing *C SERIES Loudspeakers* and accessories:

- Read and keep these instructions.
- Heed all warnings.
- Follow all instructions, particularly those pertaining to rigging, mounting, hanging and electrical connections.
- Do not use this apparatus near water.
- Clean only with dry cloth.
- Do not block any ventilation openings. Install in accordance with the manufacturer's instruction.
- Do not install near any heat sources such as radiators, heat registers, stoves, or other apparatus (including amplifiers) that produce heat.
- Only use attachments/accessories that are specified and approved by the manufacturer.
- Refer all servicing to qualified service personnel. Servicing is required when the apparatus has been damaged in any way, such as power-supply cord or plug is damaged, liquid has been spilled or objects have fallen into the apparatus, the apparatus has been exposed to rain or moisture, does not operate normally, or has been dropped.

The terms caution, warning, and danger may be used in this manual to alert the reader to important safety considerations. If you have any questions or do not understand the meaning of these terms, do not proceed with installation. Contact your local dealer, distributor, or call Community directly for assistance. These terms are defined below:

-  **CAUTION:** describes an operating condition or user action that may expose the equipment or user to potential damage or danger.
-  **WARNING:** describes an operating condition or user action that will likely cause damage to the equipment or injury to the user or to others in the vicinity.
-  **DANGER:** describes an operating condition or user action that will immediately damage the equipment and/or be extremely dangerous or life threatening to the user or to others in the vicinity.



These servicing instructions are for use by qualified service personnel only. To reduce the risk of fire or electric shock do not perform any servicing other than that contained in the operating instructions unless you are qualified to do so.

L'information de Sûreté Importante

Respectez toujours ces précautions de sécurité de base lors de l'utilisation ou lors de l'installation des haut-parleurs *C SERIES* et de ces accessoires :

- Lisez et gardez les instructions.
- Observez tous les avertissements.
- Suivez toutes les instructions, particulièrement ceux concernant le calage, support, montage et raccordements électriques.
- Ne pas utiliser cet appareil près de l'eau.
- Nettoyez seulement avec un tissu sec.
- Ne pas bloquer les ouvertures de ventilation. Installer conformément aux instructions du fabricant.
- Ne pas installer près des sources de chaleur comme les radiateurs, les cuisinières, foyers ou autres appareils (y compris les amplificateurs) qui peuvent produire de la chaleur.
- Utilisez seulement les accessoires qui sont spécifiés et approuvés par le fabricant.
- Référez tout entretien au personnel qualifié de service. Ceci est exigé quand l'appareil a été endommagé de quelque façon, incluant le fil d'alimentation et ou l'embout du fil a été endommagé, des liquides ont été renversés ou des objets sont tombé à l'intérieur de l'appareil, l'appareil a été exposé à la pluie ou l'humidité, l'appareil ne fonctionne pas normalement ou a été échappé.

Les termes attention, avertissement, et danger peut être utilisés dans ce manuel pour alerter le lecteur aux considérations importantes de sûreté. Si vous avez des questions ou ne comprenez pas la signification de ces termes, ne procédez pas à l'installation. Contactez votre détaillant, distributeur, ou Community directement pour assistance. Les termes sont définies ci-dessous:

-  **ATTENTION:** décrit une condition de fonctionnement ou une action d'utilisateur qui peuvent exposer l'équipement ou l'utilisateur aux dommages potentiels ou au danger.
-  **AVERTISSEMENT:** décrit une condition de fonctionnement ou une action d'utilisateur qui peuvent causer des dommages probable à l'équipement et/ou à l'utilisateur et à ceux se trouvant à proximité.
-  **DANGER:** décrit une condition de fonctionnement ou une action d'utilisateur qui endommageront immédiatement l'équipement et/ou seront extrêmement dangereuses et qui peut représenter un danger pour la vie à l'utilisateur et à ceux se trouvant à proximité.

Ces instructions d'entretien sont pour l'usage d'un personnel de service qualifié seulement. Pour réduire le risque de feu ou de décharge électrique n'exécutez aucun entretien autrement que ce qui est contenu dans les instructions d'opérations à moins que vous êtes qualifié pour le faire.

Introduction & Product Description

Thank you for your choice of Community's C SERIES Surface Mount Loudspeakers.

The C SERIES Surface Mount model has a unique, modern-looking streamlined architectural design. The black or white cabinet is easy to customize since it accepts a wide variety of paints. For durability and improved sonic quality, the cabinets have thick-wall, internally-reinforced ABS plastic construction. This high-impact strength construction reduces resonances, and the rounded surfaces further reduce the resonances that occur in flat-sided cabinets.

Each model is shipped as a matched pair of completely assembled loudspeakers, including everything needed for standard installations. The CS6 is a full-range model, with high and low frequency drivers and built-in crossover.

You can use 8 ohm or constant voltage distribution with the built-in 70/100 volt autoformer. Power is easy to adjust using a front-accessible power tap switch.

We urge you to read these instructions carefully and familiarize yourself with the features and installation methods before you begin the job. If you have any questions or concerns, please contact Community.

Mounting System

C SERIES Surface Mount Loudspeakers include a Vari-Tilt™ yoke mounting system, which allows low profile mounting and precise aiming over a broad pan-tilt range.

The yoke design allows for pan adjustments by sliding the yoke arm through the mounting plate and the tilt adjustments at the yoke-cabinet mounting knobs. The cabinet may be installed either horizontally or vertically and is adjustable in both directions, in either orientation. See page 9 for aiming angles achievable in each orientation.

Wiring

The wiring for the loudspeaker is achieved through the use of a 4-Pin Euroblock connector that is inserted into the recessed input connector area on the back of the cabinet. The wiring is routed through the 2 or 3 wire sealing plugs prior to terminating into the Euroblock. The selection of these gaskets is dependent on two factors: the orientation of the cabinet, and whether the cabinet wiring is being daisy-chained to other loudspeakers or terminated to a single loudspeaker. Refer to page 7 to determine the correct wiring procedure for your installation to ensure weather-resistant protection is provided.

Table of Contents

Important Safety Instructions.....	2
L'information de Sûreté Importante	2
Introduction & Product Description.....	3
Packing List and Feature Identification	4
Installation	5
Wiring	6
Aiming	9
Finalizing the Installation	10
Painting the Loudspeaker	11
Drawings / Dimensions.....	11

Compliance

Community Professional Loudspeaker products bearing the CE label meet all the requirements in the EMC directive 2014/30/EU laid down by the Member States Council for adjustment of legal requirements, furthermore the products comply with the rules and regulations referring to the electromagnetic compatibility of devices from 16 April 2016.

The Community Professional Loudspeaker products bearing the CE label comply with:

- Low Voltage Directive 2014/35/EU
- Waste from Electrical Equipment Directive 2002/96/EC RoHS

The Declaration of Conformity statement is available upon request.

Technical specifications for products can be found at www.communitypro.com

Packing List and Feature Identification

Community C SERIES Surface Mount Loudspeakers are engineered and manufactured to be rugged and they are carefully packed in sturdy cartons. However, it is wise to thoroughly inspect each unit after it has been removed from the packaging, as damage could occur during shipping.

Please note that once the shipment has left your dealer or the Community factory, the responsibility for damage is always borne by the freight company. If damage has occurred during shipping, you must file a claim directly with the freight company. It's very important to contact the freight company as soon as possible after receiving your shipment, as most freight companies have a short time limit within which they will investigate claims. Make sure to save the carton and the packing material, as most claims will be denied if these materials are not retained.

Although we illustrate a single loudspeaker below to show the included parts, in fact these loudspeakers are shipped in pairs. For a given model, this is what is included in the carton:

- Surface Mount Loudspeakers (Qty 2)
- Yoke Assembly (Qty 2)
- Input Cover (Qty 2)
- 4-Pin Terminal Connector (Qty 2)
- Wall Mount Plate (Qty 2)
- Wall Mount Pinch Plate (Qty 2)
- Vertical 2-Position Rubber Plug (Qty 4)
- Horizontal 3-Position Rubber Plug (Qty 4)
- Rubber Yoke Washer (Qty 4)
- Yoke Knob (Qty 4)
- M8 x 25mm Hex Head Bolt, SS (Qty 2)
- 8mm Flat Washer, SS (Qty 2)
- 8mm Lock Washer, SS (Qty 2)
- M3 x 13 Phillips Screw (Qty 8)
- Screwdriver (Qty 1)
- Logo tap cover (Qty 2)

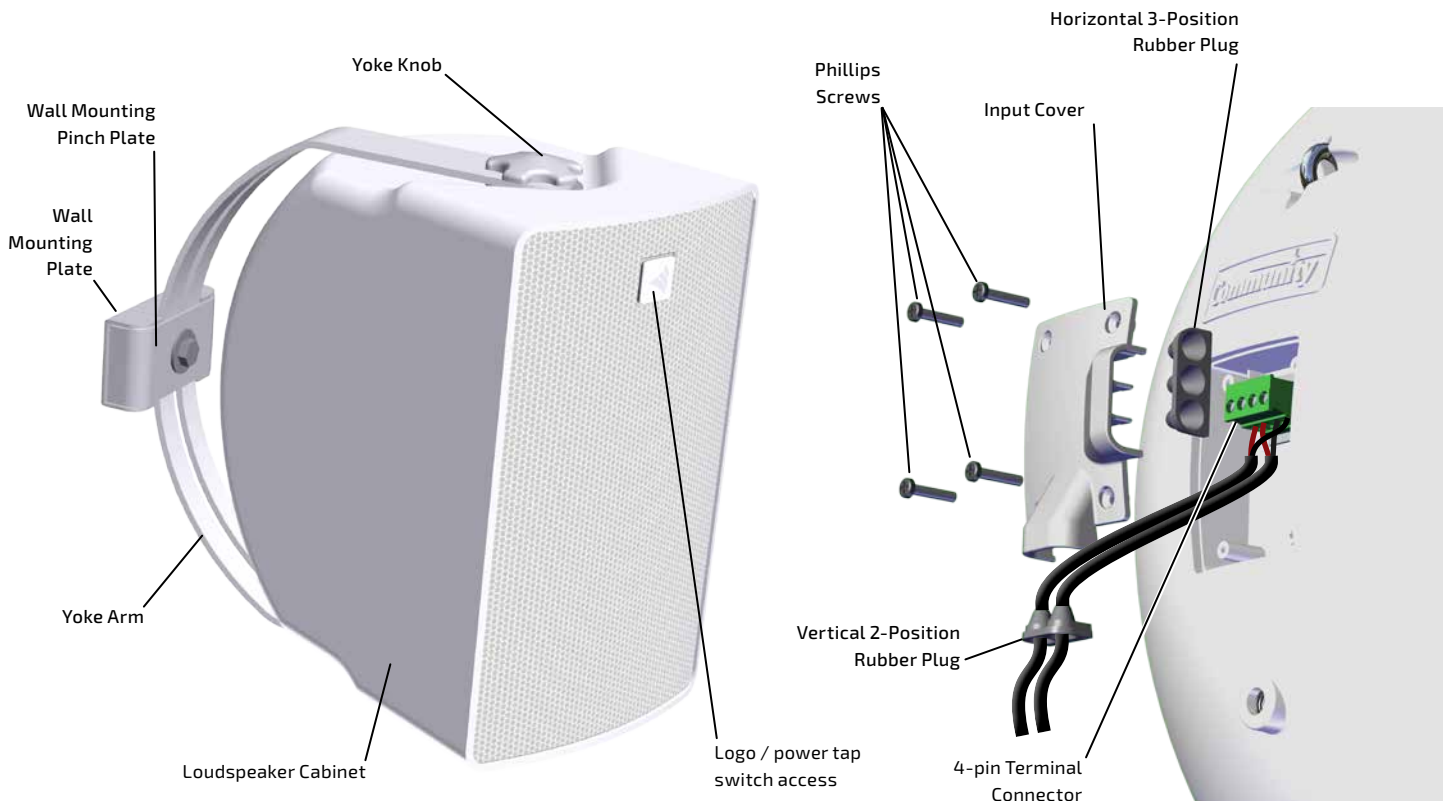

Installation

⚠ IMPORTANT: Community does not provide hardware for mounting the wall mount plate to the install surface. This hardware is customer supplied and subject to local codes and requirements. It is strongly recommended that a licensed and certified professional structural engineer approve the mounting. Severe injury and/or loss of life may occur if this product is improperly installed. The provided mounting yoke may not be suitable for all mounting orientations or environmental conditions.

1. Attach wall-mount plate to mounting surface using customer supplied hardware. (See above). Install the mounting plate to ensure correct cabinet orientation.
2. Insert the M8 bolt through the lock washer, flat washer, and the hole on pinch plate.
3. Sandwich the yoke between the pinch plate assembly and align with the wall plate.
4. The yoke arm should rest inside the notches on the mounting plate. Lightly finger-tighten the M8 bolt to loosely hold the yoke assembly together. (NOTE - Do not tighten the yoke bolt until final aiming is complete.)
5. Prior to lifting the loudspeaker into place, complete the wiring preparation (details on page 7).

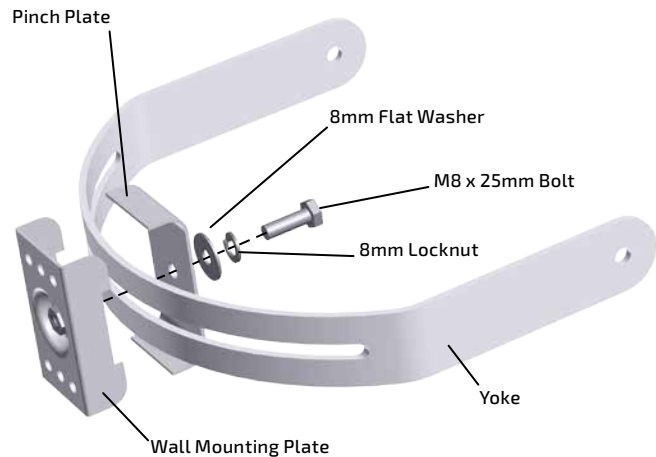
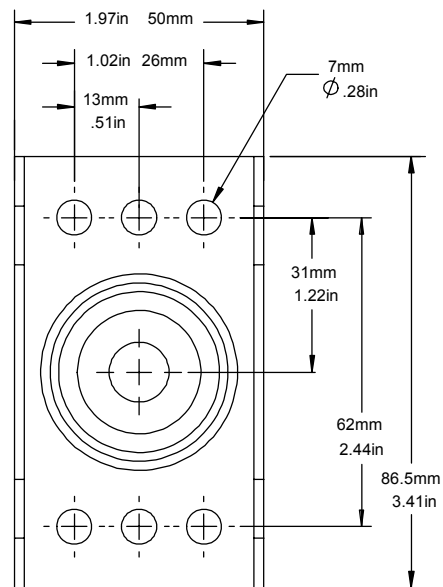

Figure 1. Yoke / wall mount assembly
Horizontal Loudspeaker Orientation
(Wall mount plate is vertical)

⚠ NOTE: All electrical and mechanical installation connections for loudspeaker lines are subject to all applicable governmental building and fire codes. The selection of appropriate electrical and mounting hardware to interface with C SERIES Surface Mount Loudspeakers lies solely with the installation professional. Community recommends that an appropriately licensed engineer, electrician, or other professional identify and select the appropriate conduit, fittings, wire, etc. for the installation.



Wall Mounting Plate Detail

Wiring

The provided 4-Pin Euroblock connector, required to wire the loudspeaker, allows for individual unit wiring or "loop-thru" wiring for connecting multiple loudspeakers in parallel. The provided input panel cover allows for multiple pairs of wires in and out of the sealed ingress. It is IP56 rated.

Determining the correct wiring location

Depending on the mounting direction of the cabinet, you will need to use one of the two provided rubber wiring plugs. Refer to the following descriptions to determine which plug is needed. An extra pair of rubber plugs is provided in case a mistake is made during installation.

Horizontal Mounting

For horizontal mounting, always use wiring cover ingress locations along the long edge of the cover. To allow for sufficient wiring bend radius in the wiring cavity, always use the ingress points that are as far away from the Euroblock connector as possible (see Figure 2a).

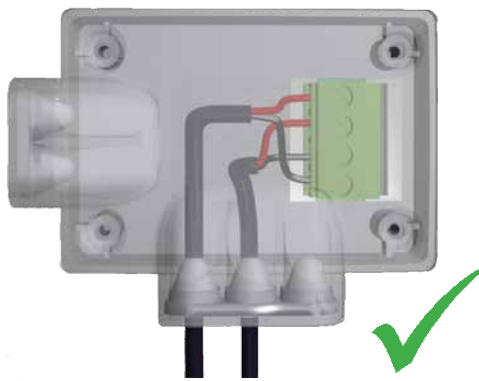

Figure 2a. Correct orientation with loudspeaker in horizontal orientation

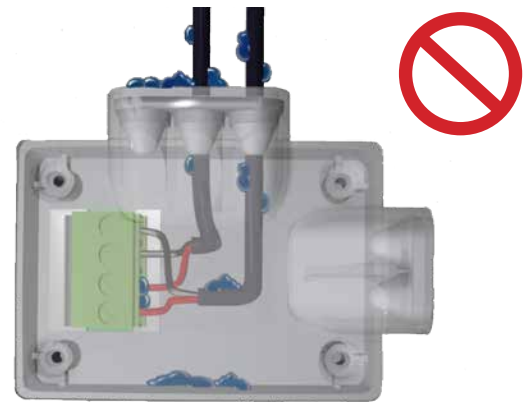

Figure 2b. Incorrect orientation with loudspeaker in horizontal orientation

Vertical Mounting

For vertical mounting, always use wiring cover ingress locations along the short edge of the cover (see Figure 3a).



Figure 3a. Correct orientation with loudspeaker in vertical orientation



Figure 3b. Incorrect orientation with loudspeaker in vertical orientation

Wiring (continued)

The rubber plugs are designed to grip cables from approximately 0.125" (3.2mm) to 0.3" (7.6mm) in diameter to prevent water ingress.

For cables 0.3" (7.6mm) up to 0.34" (8.6mm), (roughly the size of most standard 16-2 and 14-2 SJOW cables), the cable may be passed through the cover without using the rubber plugs. However, in order to preserve the IP56 rating and prevent water ingress, use of a silicone sealant around the cable is recommended. Cables with a diameter larger than 0.35" (8.9mm) cannot be used with the rear cover.

Connecting and Routing Wiring

1. Leave approximately 6" (15 cm) of cable coming out of the wall at the install point.
2. Prepare the rubber plugs by clipping the end of the rubber cone to create an opening slightly smaller than the diameter of the cable. This will allow the rubber to stretch slightly and seal around the cable jacket. A sharp razor blade or wire cutters can be used to cut the cone tip (see Figure 4).
3. Split the cable jacket approximately 1" (2.54 cm). Route the cable(s) through their respective cones in the rubber plug (see Figure 5).
4. Strip each conductor insulation back approximately 0.25" (6.4mm).
5. Connect the (+) wire to position #1 and the (-) wire is connected to position #4 on the Euro connector. If the next loudspeaker is to be connected in daisy-chain fashion, connect its wires to position #2 (+) and position #3 (-) (Refer to Figure 6).

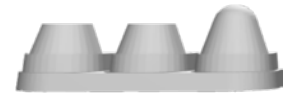

Figure 4. Trim the tips from the appropriate rubber plug



Figure 5. Insert wires through the trimmed rubber plug

! **NOTE:** The rubber plug openings are designed to receive cables, not individual conductors. This means that one plug opening should be used for a single cabinet and two would be used for a loop-thru install. Also be sure to only use one cable per plug opening. Do not attempt to route two cables in a single opening.

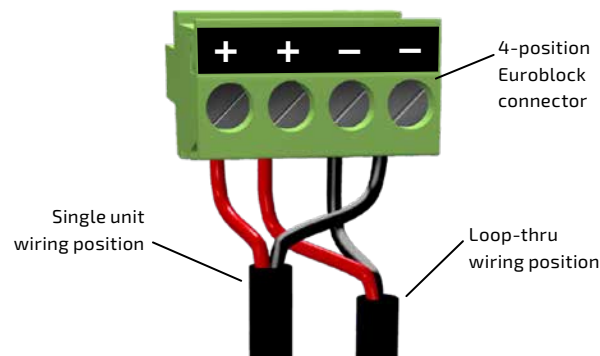

Figure 6. Wiring Connections



Figure 7. Extra silicone prevents water ingress

! **CAUTION:** We recommend applying a silicone based weather-proof sealant if not using the wiring plugs **OR** to supplement the plugs in severe weather and extended outdoor use.

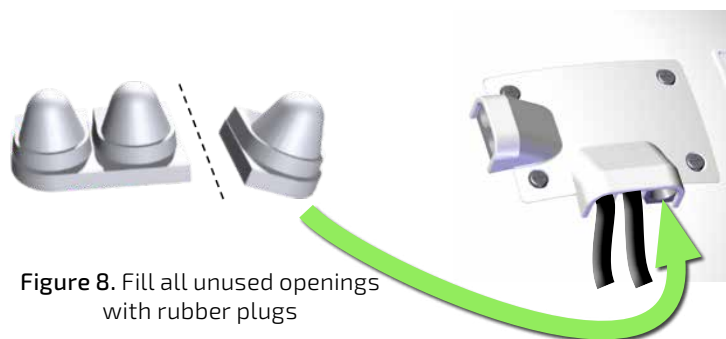

Figure 8. Fill all unused openings with rubber plugs

! **NOTE:** When wiring **WITHOUT** inserting the wires through the rubber plugs, remove only the plugs required for wiring access and install the remaining plugs to cover open spots.

Wiring (continued)

Connecting and Routing Wiring (continued)

6. Lift the loudspeaker up to the installation location with the correct orientation.
7. Press both the rubber plugs into position on the weather cover ingresses.
8. Fit the 4-pin Euroblock connector securely into the socket on the cabinet.
9. Maintaining cabinet orientation, use the 4 weather cover screws to secure the weather cover to the back of the cabinet (Figure 9).
10. Attach the loudspeaker to the yoke. Place each rubber washer between the yoke end and cabinet and screw in the yoke knobs. Do not fully tighten the knobs.
11. See the page 9 for final aiming procedures.

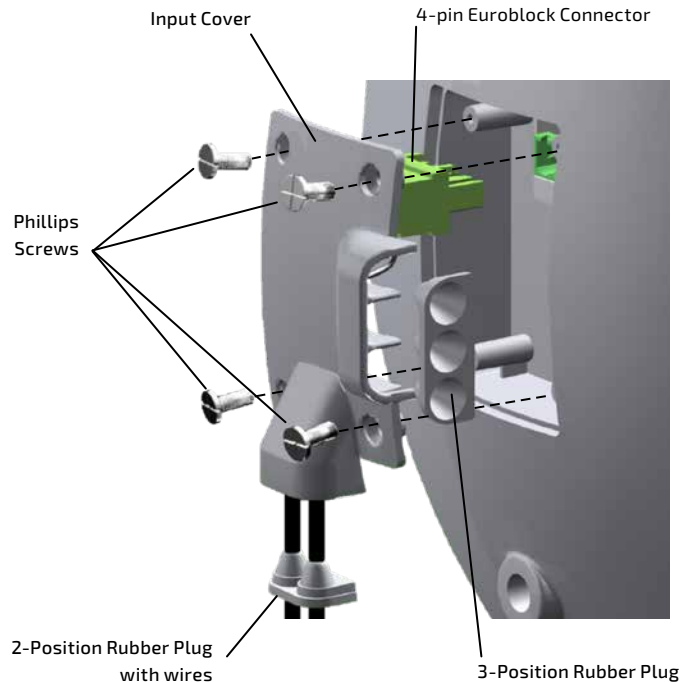

Figure 9. Install the weather cover



WARNING: Community does not recommend the use of any liquid thread locking compound, such as Loctite, on the yoke to cabinet mounting hardware during the installation of this product. The chemicals in the thread lockers may soften the ABS material used in the molding of this product. Liquid thread locker coming in contact with the ABS cabinet may cause weakening and failure of the mounting points.

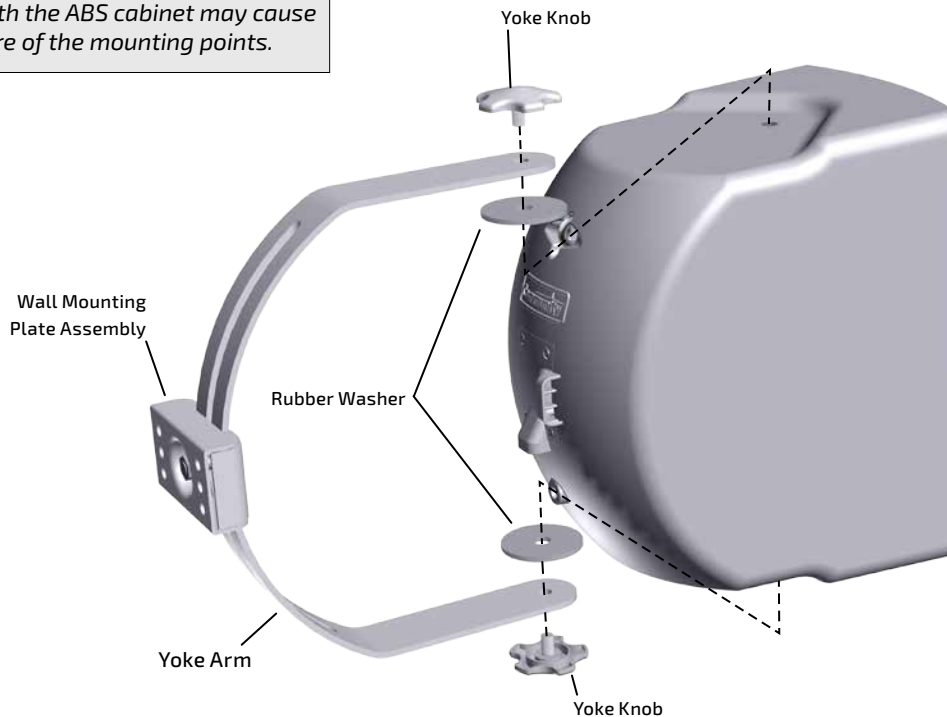

Figure 10. Attach the loudspeaker to the yoke

Aiming

The Vari-Tilt yoke assembly allows for horizontal and vertical aiming adjustments of the loudspeaker. The maximum angles for each direction are shown in the table below.

Aiming the Loudspeaker

1. Supporting the weight of the cabinet, gently rotate the yoke through the yoke mounting plate / pinch plate assembly until the desired aiming angle is achieved.
2. Once in position, use an open-ended wrench and tighten the bolt firmly to lock the yoke into position (see Figure 11).
3. Loosen the two yoke knobs and rotate the loudspeaker until the desired aiming angle is achieved.
4. Once in position, re-tighten the yoke knobs by hand to secure the loudspeaker (see Figure 11). Use of thread locking adhesive or tools on these knobs is **NOT** recommended. (See WARNING on page 8).
5. A safety cable attachment loop is built into the rear of the loudspeaker cabinet (Figure 12). Securely attach the cable to a secondary mounting point on the structure.

! **IMPORTANT:** Always use a safety cable! The safety cable must be connected directly to the loudspeaker enclosure and terminated at a secondary mounting point.

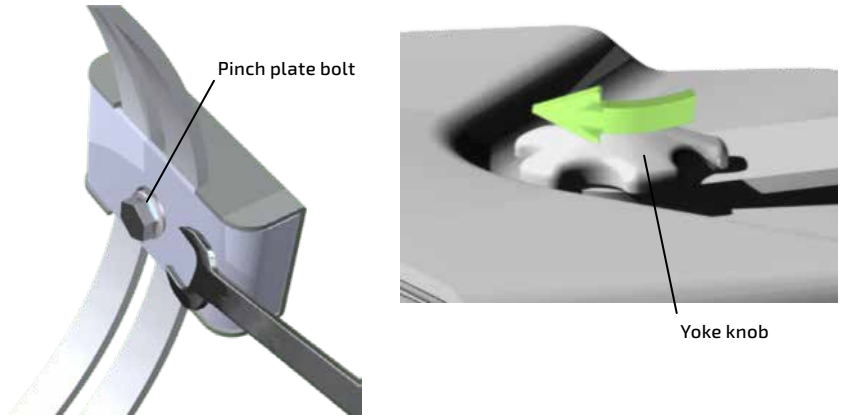

Figure 11. Secure loudspeaker aiming angle

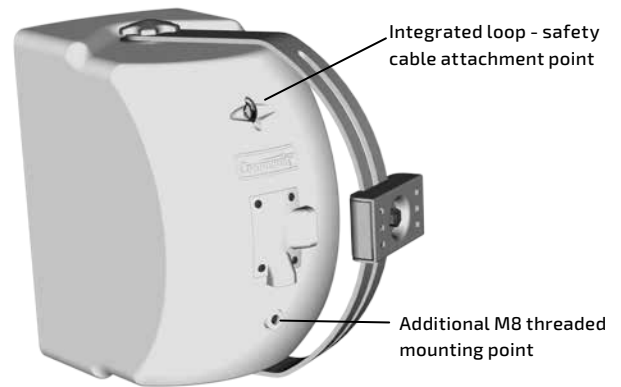
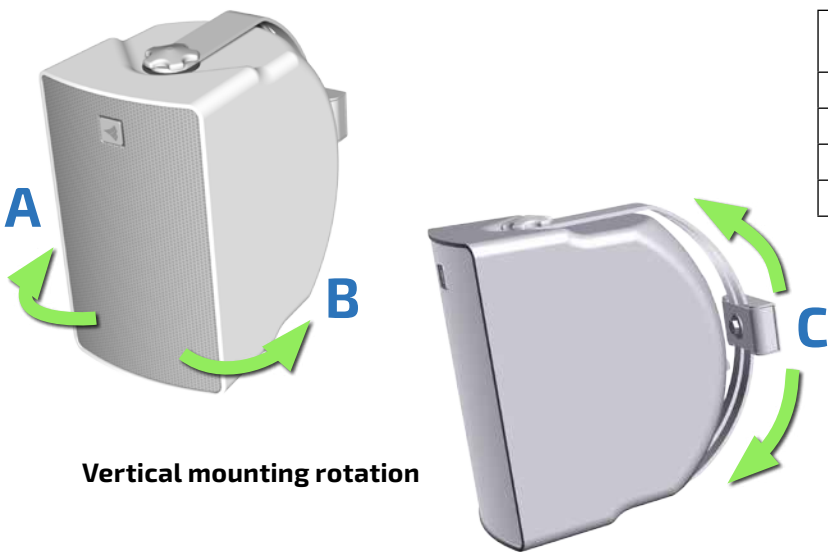

Figure 12. Safety cable mounting points



	Vertical Mount Maximum Aiming Angle	Horizontal Mount Maximum Aiming Angle
	CS6	CS6
A	56°	50°
B	56°	50°
C	50°	56°

Figure 13. Maximum rotation angles for each aiming direction

Finalizing the Installation

The final step is to verify the tap-position switch is correctly set for your system requirements.



IMPORTANT: Adjustment of the tap-position switch should be done before applying power to the loudspeaker.



CAUTION: Adjustment of the tap-position switch should only be performed without power to the loudspeaker to prevent potential damage to internal components.

Adjusting the Tap-Position Switch

1. The logo plates are in a separate bag in the shipping carton. If the logo plate is already installed on the grille, use the provided flat-blade screwdriver to carefully pry the logo plate away from the loudspeaker grille.
2. Referencing the Tap Position Switch label behind the logo, use the flat-blade screwdriver to adjust and verify the correct setting for the system (Figure 14).
3. Taking note of the cabinet orientation, install the logo plate with the logo pointing to the left (Figure 15).
4. If necessary, a dry cloth can be used to remove fingerprints and light dirt or dust that may have resulted during installation.



Note: The enlarged label shows the 70-volt/100-volt and 8 ohm power tap settings for the CS6. With 100-volt distribution, **do not use the N.C. setting.**

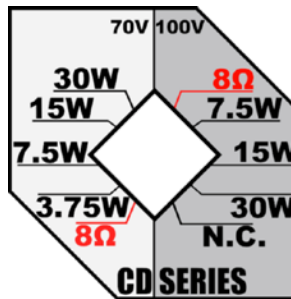

Note: The tap switch can only be adjusted using a flat-blade screwdriver



Figure 14. Adjust the tap switch



Figure 15. Correct orientation of logo plate

Painting the Loudspeaker

Type of Paint

These loudspeakers' ABS plastic cabinets accept almost any type of latex or enamel (oil based) paint. We recommend application of two coats. Please note that painting the grille requires spray painting.



CAUTION: NEVER use abrasives, gasoline, kerosene, acetone, methyl ethyl ketone (MEK), paint thinner, harsh detergents or other chemicals. These chemicals and agents may permanently damage the finish. Some are also toxic and highly flammable.

Painting Process

Follow this procedure to obtain the best results:

1. Remove the grille.
2. Clean the grille assembly and the loudspeaker cabinet by rubbing them with a lightly dampened cloth. **Do not** use abrasives such as sandpaper or steel wool.
3. Mask the loudspeakers so that the surrounds, cones and center areas will not receive any paint. We advise against using conventional masking tape and NEVER use duct tape in this application; these kinds of tape generally leave adhesive residue that can be difficult to remove and that may actually cause damage. Painters tape is best.
4. After cleaning, apply two or more thin coats of either latex or oil-based paints. Latex paint will adhere better if an oil-based primer is used first. Apply the paint with a roller or brush, or spray it on, except as noted below.
5. The grille should be painted separately, and **not** in place on the loudspeaker. We further recommend that you remove the grille's internal cloth mesh, then spray paint the grille assembly. Avoid using a roller or brush to paint the grille as its metal perforated holes may become clogged with paint, which degrades sound quality and also may attenuate the sound. Reinstall the internal cloth mesh (or if damaged install a new cloth mesh).

Drawings / Dimensions

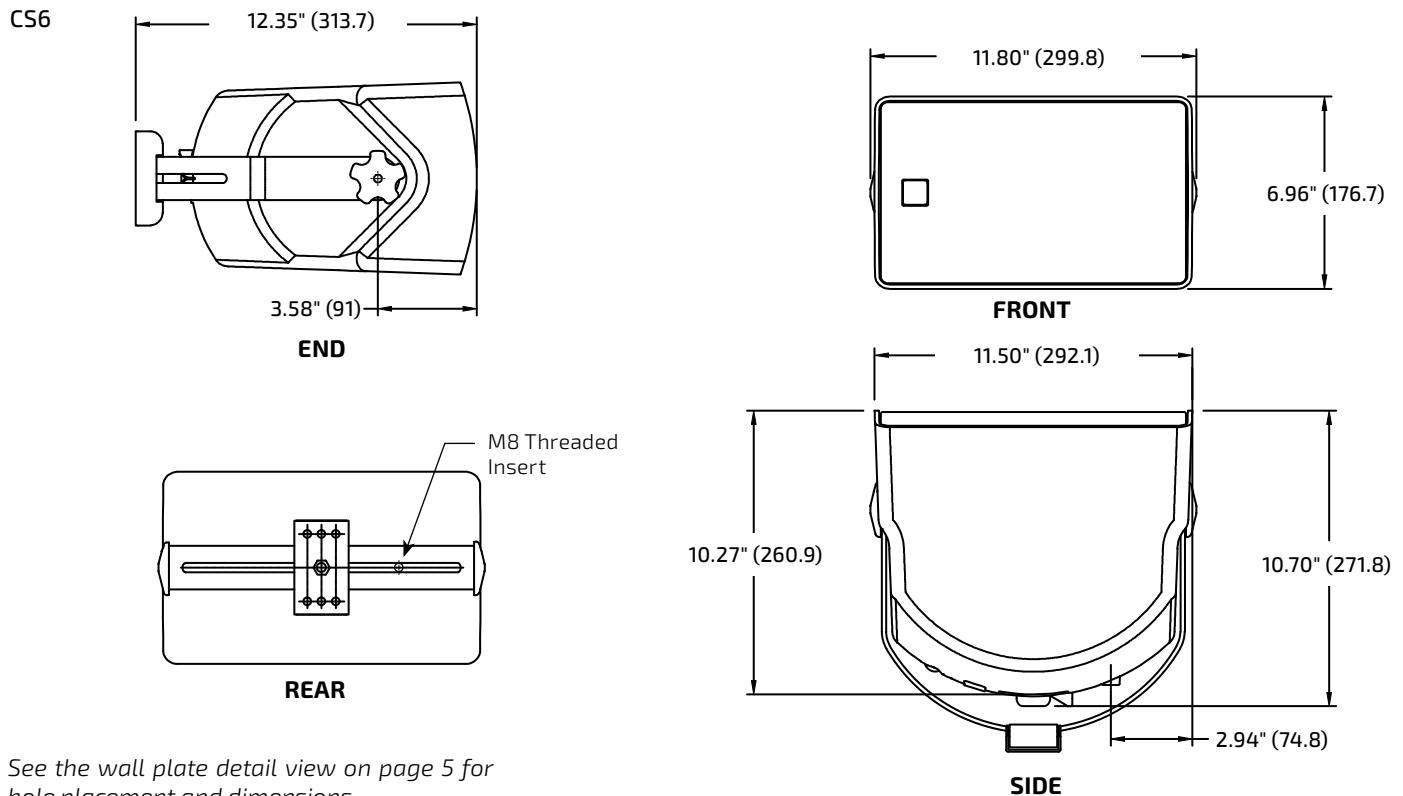

See the wall plate detail view on page 5 for hole placement and dimensions.

Warranty Information and Service

Transferable warranty "(Limited)" valid in the USA only

The C SERIES Loudspeaker Systems are designed and backed by Community Professional Loudspeakers. For complete warranty information within the USA please refer to Community website. Please call 610-876-3400 to locate your nearest Authorized Field Service Station.

For Factory Service call 610-876-3400. You must obtain a Return Authorization (R/A) number prior to the return of your product for factory service.

Warranty information and Service for countries other than the USA

To obtain specific warranty information, visit the website at communitypro.com/warranty. To obtain available service locations for countries other than the United States of America, contact the authorized Community Distributor for your specific country or region.

Shipping damage

If the product is damaged during transit you must file a damage claim directly with the freight company. Be sure to save the carton and packing materials, as damage claims can be denied if these materials are not retained. If evidence of physical damage exists upon arrival, be cautious before signing a delivery acceptance receipt. Often, the fine print will waive your right to file a claim for damage or loss after you sign it. Make sure that the number of cartons shown on the freight documents have actually been delivered.

Find the latest online

The latest version of this manual and the most recent product information is always available at Community's website: www.communitypro.com



Community Professional Loudspeakers

333 East Fifth Street, Chester, PA 19013-4511 USA

Phone: (610) 876-3400 • Fax: (610) 874-0190

www.communitypro.com